

# NEW BIOSPHERE AGRICULTURE

**Biodiesel**  
&  
**Hydrogen**

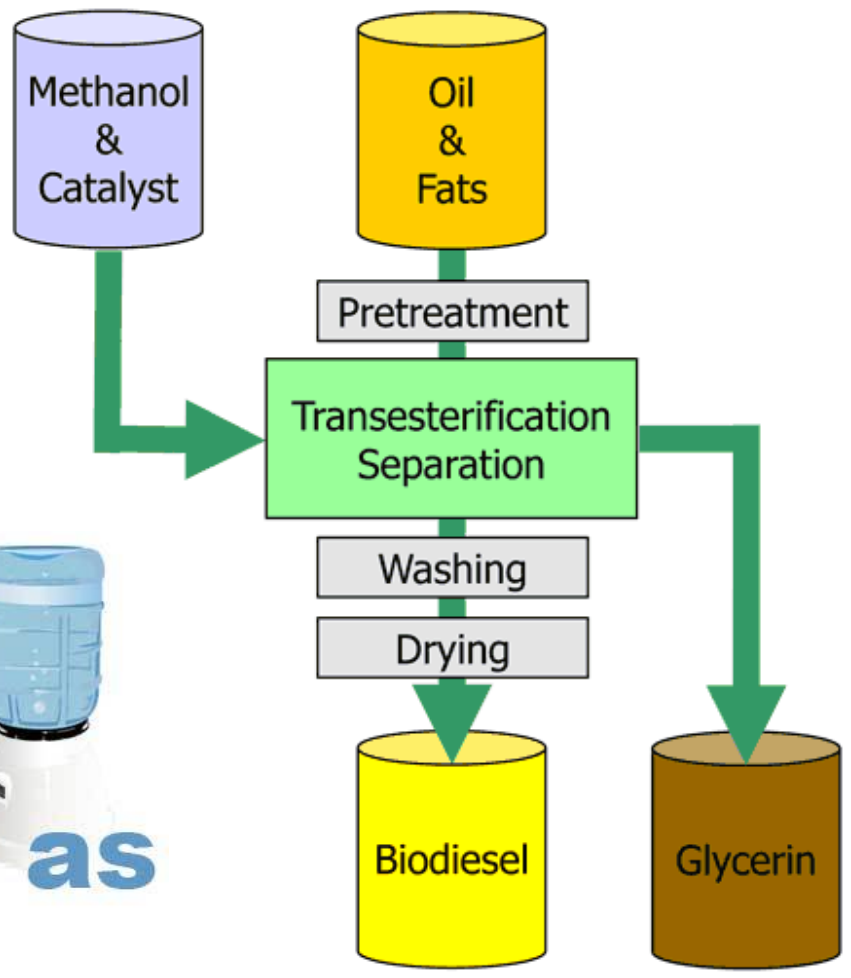

PASCAS FOUNDATION (Aust) Ltd  
ABN 23 133 271 593

Queensland, Australia

Em: [info@pascasworldcare.com](mailto:info@pascasworldcare.com)  
Em: [info@pascashealth.com](mailto:info@pascashealth.com)

Pascas Foundation is a not for profit organisation

[www.pascasworldcare.com](http://www.pascasworldcare.com) [www.pascashealth.com](http://www.pascashealth.com)

## Biodiesel supplemented with Hydrogen Gas

Consider that you are in a remote region and your vehicles and freestanding engines run on diesel.

Then consider reducing your dependence upon diesel fuel by supplementing with hydrogen.

Further consider producing your own biodiesel.

Read on.



# Bio diesel

Sustainable Camden • Sustainable Fuel

[http://www.camden.nsw.gov.au/page/biodiesel\\_project.html](http://www.camden.nsw.gov.au/page/biodiesel_project.html)



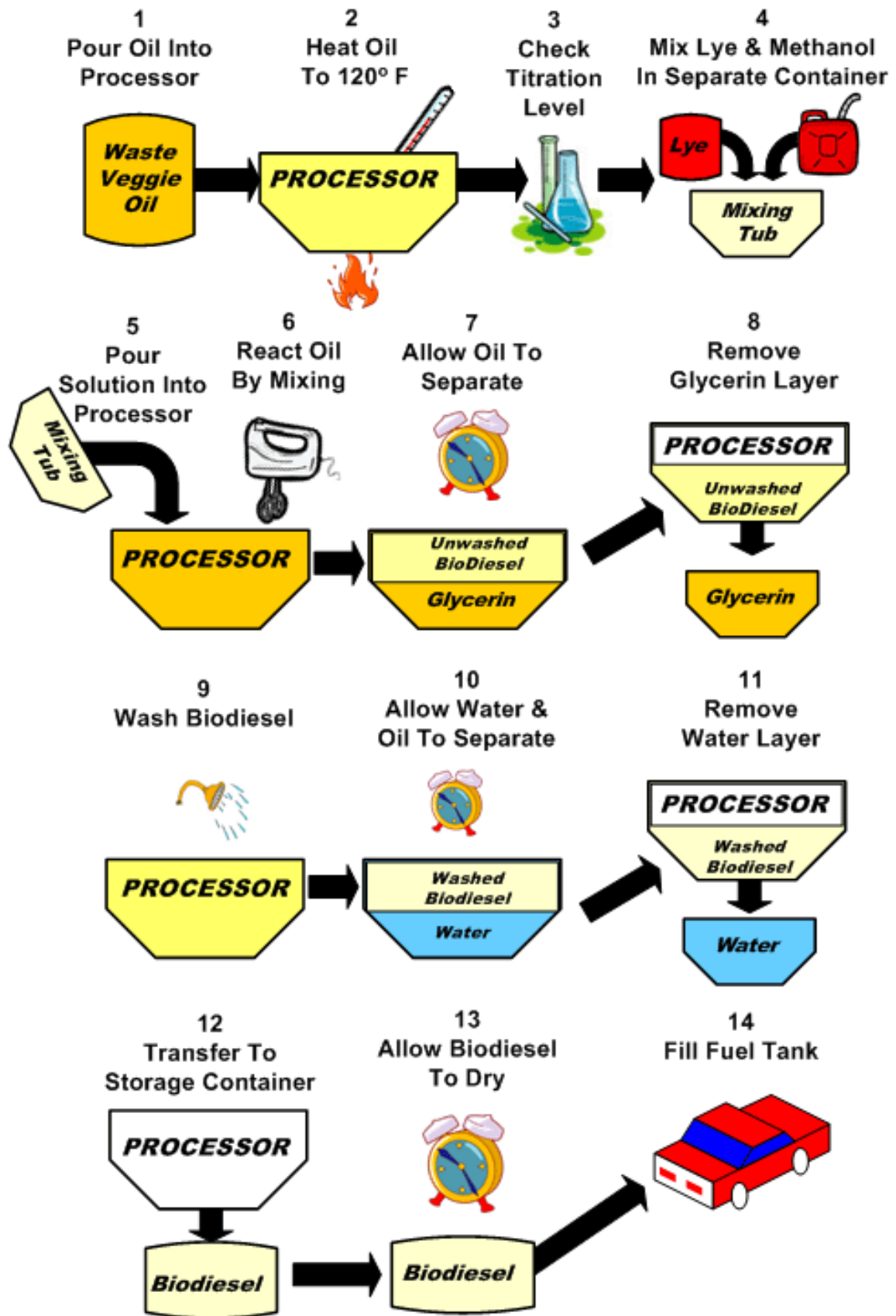

# Production Time

People produce biodiesel in 20 to 100 gallons batches as it takes approximately two to seven days to make.

An idea of production times is as follows:

Oil collection 1 hour

Oil filtration 1 to 2 hours

Titration of oil 15 minutes

Oil transfer 15 minutes

Heating oil 2 to 4 hours

Methoxide production 20 minutes (methanol and catalyst)

Mixing into oil 30 Minutes

Oil settling 8 to 10 hours (typically overnight)

Draining glycerin and soap 5 to 10 minutes

Transfer to wash 15 minutes

First mist wash 2 to 3 hours

Second mist wash 2 to 3 hours

First bubble wash 6 to 8 hours

Second bubble wash 6 to 8 hours (typically overnight)

Transfer to drying container 15 minutes

Drying Variable

Storage transfer 15 minutes

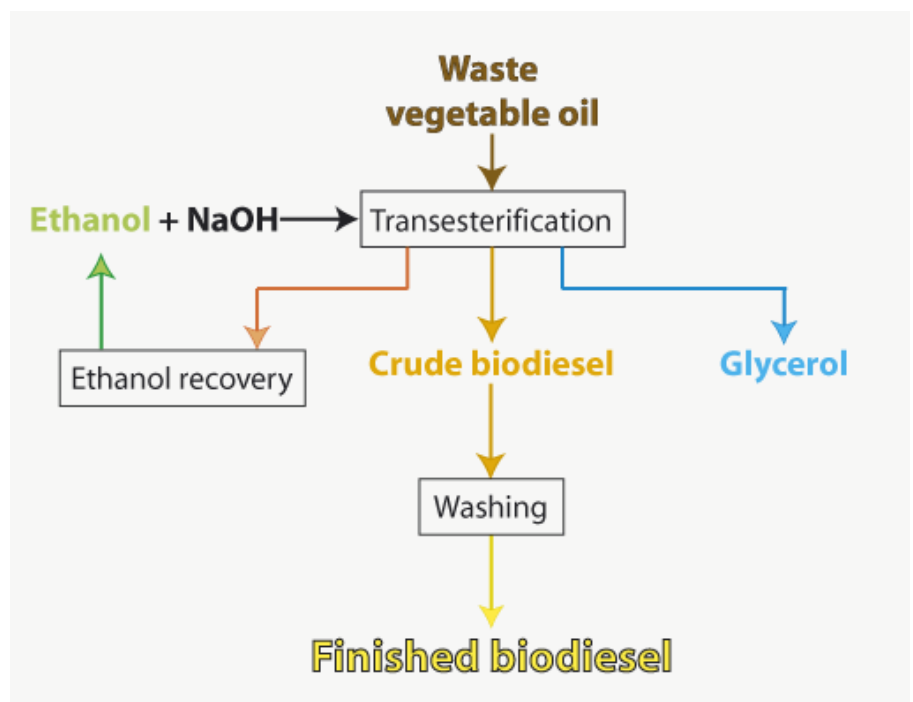



# Biodiesel: Do-it-yourself production basics

<http://attra.ncat.org/attra-pub/biodiesel.html>

## About biodiesel

Biodiesel is made by chemically reacting vegetable oil or animal fat or a combination of oils and fats with alcohol, usually nearly pure methanol, denatured ethanol or ethanol. The mixture is then combined with a catalyst: an alkaline chemical such as potassium hydroxide or sodium hydroxide, also known as lye. The oil is chemically acidic. The combination of the alcohol and catalyst, also known commonly as methoxide, is chemically a base.

This chemical reaction breaks the fat molecules in the oils into an ester, which is the biodiesel fuel, and glycerol. This reaction is called transesterification. Because the biodiesel is not as dense as the glycerol, the biodiesel floats on top of the glycerol and may be poured or pumped off, or the glycerol can be drained off the bottom.

The fuel can then be filtered and used in heating or lighting applications. Although some people use the fuel in diesel engines without further processing, it is strongly recommended that impurities such as soap, un-reacted alcohol and catalyst be removed first by a washing process. Unwashed biodiesel is caustic and incompatible with modern fuel-injection systems and use will lead to component failure. Modern diesel engines made after 2004 require high-quality fuel to avoid problems.

Anyone who has experience with diesel engines knows that diesel fuel will turn into a waxy gel at low temperatures. This is called the gel point and fuel at the gel point cannot be pumped until it is warmed up. The temperature at which the fuel will no longer pour is called the pour point.

Biodiesel has a higher pour point than No. 2 petroleum diesel. This means biodiesel gels at a higher temperature. Some oil feed stocks, such as coconut oil or animal fats, result in biodiesel that will gel at relatively high temperatures, whereas biodiesel made from canola or rapeseed oil will have a lower gel point. Biodiesel is commonly blended with No. 1 petroleum diesel to lower the gel and pour points. Biodiesel should be stored at above-freezing temperature, and temperature controlled heaters can be installed on tanks and fuel lines in diesel vehicles. Some vehicles have heated fuel filters that also help keep biodiesel above the gel point.

## Introduction

Biodiesel is an alternative to petroleum diesel. Biodiesel is permanently thinned plant- or animal-based oil, with a viscosity approximating that of standard No. 2 diesel fuel. The fuel is called biodiesel because it is made from mostly biodegradable materials and can be used as fuel in diesel engines.

Biodiesel can also be used in boilers or furnaces designed to use heating oils or in oil-fuelled lighting equipment. It can be used neat,



meaning 100-percent biodiesel, or it can be blended with petroleum diesel.

The purpose of this publication is to describe how people can make biodiesel to provide fuel for diesel machinery on a farm or ranch. Please note that biodiesel used on public roads is subject to federal, state and local taxes, just as petroleum diesel is.

Biodiesel can be made in any quantity, from 1 cup to many gallons. The process described here is a batch process, which is appropriate for an individual farmer or rancher. Steady flow processes are more appropriate for biodiesel manufacturing plants. Because small mistakes are preferable to large mistakes, people interested in making biodiesel may want to start with small batches and work up to making larger batches.

## Hazards

Making biodiesel is relatively simple; some say it is easier than making beer.

However, there are caustic, toxic, volatile and flammable chemicals involved. The potential for personal injury and property damage is very real. Neither the author nor anyone else associated with this publication is responsible for potential mistakes, injuries and damage. Do not rely solely on this publication for information about making biodiesel; carefully study other publications and start small.

Wear an appropriate respirator when making biodiesel. The only approved respirators for methanol are respirators with external air supplies. For information on obtaining a respirator, see the **Further resources** section at the end of this publication. Other necessary equipment includes heavy rubber gloves, safety goggles and clothing that will protect your skin from chemicals, especially methanol. Methanol can be absorbed through the skin and cause illness, blindness and debilitation.

Heating the oil to remove the water and transferring the heated oil are two potentially dangerous steps in the process of making biodiesel. When heating the used oil, be careful to keep it from spattering and making the floor slippery. Be cautious about using burners or electric heaters, just as if you were cooking. Hot oil will melt plastic buckets, creating a mess. Be careful to cool hot oil to below 120° degrees Fahrenheit (50°C) before pouring it into a plastic bucket.

Do not use anything that comes in contact with biodiesel or the chemicals used to make biodiesel for food production.



<http://www.murphysmachines.com/MM500.html>

Making biodiesel requires a well-ventilated area to reduce the danger of fire and explosion and exposure to methanol. Methanol can vaporize, and when mixed with the proper amount of oxygen and an ignition source, can ignite with an invisible flame. When making biodiesel in larger quantities, make it outside or in a place where there is no chance of a spark or flame coming in contact with the methanol. Any wiring in indoor areas where methanol is used must be explosion-proof.

## Storage of chemicals and biodiesel

Feedstocks and finished biodiesel must be properly stored. Methanol is a poison. Avoid all contact with methanol, including skin contact and breathing in fumes. Contact with methanol can cause irreversible illness, blindness and death.

Because methanol absorbs water it should not be stored in any open container.

Methanol should be stored in appropriate, sealed containers and containers should be clearly marked as containing methanol. Catalyst materials like sodium hydroxide (NaOH) and potassium hydroxide (KOH) are strong bases and extremely caustic. These chemicals also absorb water and will become unusable unless kept in a tightly sealed container.

Oil feed stocks can go rancid or even be rancid when acquired. Avoid rancid oils.

Used oil should be turned into biodiesel as soon as possible in order to keep it from going rancid and increasing the amount of free fatty acids. Rancid, wet or heavily used oil produces less biodiesel and may not even react enough to make biodiesel.

Finished biodiesel can be safely stored for six months.

Improper storage of biodiesel, waste vegetable oil and glycerol can attract rodents. Be careful to keep a clean workspace and dispose of waste quickly. Mice and rats can quickly chew through plastic containers, so be vigilant.

Keep the work area secure from small children and pets, as the biodiesel can have an attractive, sweet smell.

Biodiesel-soaked rags and paper towels can spontaneously combust and care must be taken to avoid this possibility.

Finished biodiesel should be stored in steel drums, poly totes or yellow diesel cans, and these containers should be clearly marked as containing biodiesel.

Biodiesel is a good solvent. It will dissolve rubber and some plastics, remove paint, oxidize aluminum and other metals and has been reported to destroy asphalt and concrete if spills were not cleaned quickly.

Most petroleum fuelling equipment can be used for biodiesel but the equipment degrades more quickly. For more information, see the ATTRA publication *Biodiesel Use, Handling, and Fuel Quality*.

## Materials

As mentioned above, biodiesel production requires three inputs: oil or fat, alcohol and a caustic, strong-base catalyst. Approximately 80% by volume of the feedstock of biodiesel is vegetable oil or animal fats and about 20% is methanol. Proper reaction of the raw oil requires 20%. For example, a proper



ratio is 10 gallons of oil to 2 gallons of methanol. The ratio of catalyst varies depending on materials used. One gallon of raw oil yields nearly 1 gallon of finished fuel.

New, degummed vegetable oil or waste vegetable oil from restaurants can be used for the oil component. The better the quality of the oil, the easier it is to make high-quality biodiesel. Oilseed farmers can press and degum oil or get pressed raw oil. See the ATTRA publication *Oilseed Processing for Small-scale Producers* for more information.

Methanol, or wood alcohol, was once made through pyrolysis of wood, but now methanol is made primarily from natural gas. It is used as a gas-line antifreeze and for racing fuel. Methanol is available from chemical suppliers. Methanol in 55-gallon drums is available from fuel dealers, auto parts stores or speed shops. HEET gas-line antifreeze is 99-percent pure methanol and can be used to make small batches of biodiesel. Be sure to purchase HEET that is sold in yellow bottles. Iso-HEET, which is sold in red bottles, is isopropyl alcohol and will not work. Do not assume that fuel-line antifreeze is pure methanol unless it is labelled as such. Be sure to use nearly pure methanol.

For the catalyst, sodium hydroxide (NaOH, caustic soda or lye) or potassium hydroxide (KOH, caustic potash) can be used. Until recently, sodium hydroxide was commonly sold as a drain cleaner in the form of Red Devil-brand lye and was available from hardware stores and many grocery stores. It has been discontinued by the manufacturer. If purchasing another brand of lye drain cleaner, make sure it is pure lye. Potassium hydroxide is less commonly available, but can be purchased through chemical supply houses or farm chemical suppliers.

The amounts of methanol, potassium hydroxide and raw oil used to make biodiesel are adjustable, as long as the following formula is followed: 1000 millilitres of oil to 200 millilitres of methanol to 7 grams of potassium hydroxide. If you prefer to use sodium hydroxide, the correct amount in the formula would be 3.5 grams. For used oil, see the section on How to do a titration below.

## **Sodium hydroxide versus potassium hydroxide**

Sodium hydroxide (NaOH) is the least expensive and most commonly used alkaline component in the small-scale biodiesel production process. However, in recent years, potassium hydroxide (KOH) gained popularity because of its superior catalyst properties. Potassium hydroxide dissolves more easily in methanol and is less sensitive to water. In addition, the glycerol, or glycerin by-product of processing with potassium hydroxide, remains liquid and is easier to dispose of. The by-product can also more safely be added to compost piles, used in small quantities as a supplement to animal feed for ruminants or poultry and applied as potassium fertilizer. Using sodium hydroxide contaminates the wash water with salts, rendering it inappropriate for land application. Sodium hydroxide glycerol does have advantages of its own: it makes a superior base for soap or degreaser.

## **Cost**

In addition to the initial cost of the processing equipment, biodiesel production costs include the chemicals used in the reaction, gas or electricity expenses and labour. Feedstocks can range from new food-grade cooking oil to animal fat renderings. The cost of the feedstock is very specific to the producer's location and operation. Waste oil from restaurants is becoming a valuable commodity, but

many local restaurants are still willing to give producers waste oil for free. Farmers who grow oilseeds may be able to press oil at the farm for a relatively low cost.

Methanol costs fluctuated wildly in recent years, along with gasoline and natural gas prices. Expect to pay roughly 25% more for methanol than the current pump price for gasoline. Look in the phone book for fuel suppliers or speed shops. Catalyst costs start at about US\$2.50 per pound. Shop around to get the best price. Remember, hazardous chemical shipping costs can be significant for chemicals purchased over the Internet.

As of 2009, farmers can expect to produce biodiesel from free, waste grease for between \$1 and \$2 a gallon, before accounting for labour and paying any applicable state and federal road tax.

## **Collecting waste vegetable oil (WVO)**

Although some biodiesel producers pay for waste vegetable oil, it is often available for free from restaurants. Shop around. Smaller restaurants may let producers pick up waste oil in buckets or drums, if the producer provides exchange buckets. Find out when the fryer oil is to be changed, and pick it up warm if possible. To get the best oil, talk to the restaurant owner and, more importantly, to the head cook, and inform them about the project and oil requirements. Most restaurant owners will be happy to work with producers who are conscientious and don't make a mess. Do not take oil from grease Dumpsters at the back of a restaurant. The oil may have excess water and be of poor quality. Taking oil may also constitute theft. Check with state and local governments for any necessary permits, as some jurisdictions charge fines for improper disposal of used oils.

## **Making your first batch of biodiesel**

There are many techniques for making biodiesel in batches from 1 cup to 90 gallons. Many kits are available for sale online, as well as do-it-yourself plans. Check the Further resources section for links. Regardless of the scale of the operation, the same six basic steps apply.

### **1) Collect oil**

There are many sources of oil, including growing oilseed crops and collecting waste oil. Some basic rules apply regardless of the source. Oil must be relatively free of solids and water. If collecting used cooking oil, work with establishments that change their oil regularly. This means at least once a week, depending on amount of use. The quality of the oil is important, too. Soy or canola oil is preferred because tropical oils and animal fats require more chemicals and produce a finished biodiesel with a higher gel temperature.

### **2) Test the oil**

Waste vegetable oil contains free fatty acids (FFA), and the amount of free fatty acids in the oil is very important because it determines the quality and quantity of the fuel produced, as well as the amount of chemicals required and the cost per gallon. Titration is a simple technique used to determine the quantity of free fatty acids in oil. When using waste oil, try to use oil with a titration value of five or below. Titration is also discussed later in this publication.

### **3) Process the oil**

The reaction between oil and the methanol-catalyst mixture, known as methoxide, can take place in a container of any size, but the container needs to be resistant to the corrosive nature of the oil and chemicals involved. On a small scale, a glass beaker or jar or a 1-litre plastic bottle are generally safe bench-top vessels. See the Making a table-top batch of biodiesel section of this publication for more information about producing biodiesel in a 1-litre plastic bottle. Some older literature refers to mixing biodiesel in a blender. **DO NOT** use a blender to mix a small batch of biodiesel. The reactants dissolve rubber gaskets, causing leaks. The violent mixing can also cause splashing of caustic chemicals. On a larger scale, a closed steel container is the safest option. See the section about batch processors for more information.

### **4) Remove glycerol**

After the reaction, the glycerol by-product will settle to the bottom of the vessel. This glycerol must be removed before the biodiesel can be used. Most larger reactors include a drain at the bottom of the vessel that allows the denser by-product to be removed. In a bench-top situation, the biodiesel can be poured off or removed with a pipette or baster.

### **5) Wash and dry the biodiesel**

Even after the reaction has taken place and the by-product has been removed, the biodiesel can contain impurities, including soaps and residual glycerol, methanol and lye. Passing a small quantity of water through the biodiesel removes the impurities and stops any remaining chemical reaction.

### **6) Dispose of the glycerol**

Proper disposal of the by-product is essential. The glycerol contains unconsumed methanol and catalyst, which can find their way into groundwater. See the section titled Methanol recovery for more information on this process.

## **How to do a titration**

As stated in the box above, titration is a simple laboratory technique used to determine the level of free-fatty acids in used oil, and the amount of reactant chemicals that you will need to completely process your feedstock. Follow these instructions to determine the proper amount of catalyst before making each batch of biodiesel from waste oil.

### **Materials**

1) One bottle of isopropyl alcohol.

In the United States, Iso-HEET Premium Fuel System Dryer & Antifreeze, in a 12 fluid ounce red bottle, is available at auto parts stores and is about 100% isopropyl alcohol. Isopropyl alcohol is also available at pharmacies.

2) One bottle of phenolphthalein (preferred) or phenol red.

Phenolphthalein is available at hot tub stores and home centres.

3) One litre of 0.1% catalyst in distilled water.

It is important to measure the catalyst very accurately. The accurate amounts are 1 gram of catalyst (sodium hydroxide or potassium hydroxide) dissolved in 1 litre of distilled water.

In the absence of a scale capable of measuring small amounts, one way of achieving precise measurements is to measure out 10 grams of catalyst and dissolve it into 1 litre of distilled water. Now take 100 millilitres of this water and mix it with 900 millilitres distilled water. You now have 1 gram of catalyst in 1 litre of distilled water. A local pharmacist or high school science department can also do the measuring. Leftover solution can be stored in a sealed container for future test batches. Remember sodium hydroxide and potassium hydroxide are very caustic and even a very small amount can burn skin.

### **Equipment**

1) A 1-cup jelly jar or other similar glass container.

Remember to never use biodiesel production containers for food preparation.

2) Two 1-millilitre syringes with graduations marked on the side.

Note that one syringe is for oil and one is for the lye-water mixture. Always use the same eyedropper for the same chemical; do not mix them up.

3) Safety glasses and rubber or nitrile gloves.

### **Procedure**

1) Pour 10 millilitres of room-temperature isopropyl alcohol into the 1-cup jelly jar.

2) Add 2 or 3 drops of phenolphthalein to the alcohol.

3) Using one of the eyedroppers, add the 0.1-percent solution drop by drop until the alcohol just starts to turn red. Stir the alcohol while dropping in the 0.1-percent solution.

4) Using the other eyedropper, add exactly 1 millilitre of the oil to be titrated. Now, fill the eyedropper with 10 millilitre of 0.1-percent solution. Start dripping this solution into the mixture until it stays pink for at least 20 seconds.

5) Keep track of how many millilitres of 0.1-percent solution are needed for the liquid to turn and stay red. The number of millilitres of 0.1-percent solution needed is equal to the number of extra grams of pure catalyst needed to produce the proper reactions to make biodiesel. For example, if it takes 3

millilitres of 0.1-percent solution to turn the oil and isopropyl alcohol solution to a base, add 3 grams of catalyst to the 3.5 grams of sodium hydroxide or 4 grams of potassium hydroxide needed for new oil, for a total of 6.5 grams of sodium hydroxide or 7 grams of potassium hydroxide.

## Choosing a scale of production

After trying a table-top batch, decide on a production system that is scaled to fit available space, available feedstock and fuel needs. Batch mixing can be done on a variety of scales, and there are several system designs to consider. Batches of 10 gallons (38 litres) or less can be mixed with gentle agitation or stirred with a paint mixer. It is a simple, inexpensive process, but this type of paddle mixing can leave unreacted material and lead to lower-quality fuel. Mixing in an open-top container can lead to splashing chemicals and the release of dangerous and flammable methanol fumes. Most popular small-scale production systems currently in use are in the 30- to 50-gallon (110 – 190 litres) range and utilize circulating pumps to provide consistent mixing in a closed mixing container.

Although a small-scale mixer or crude paddle mixer may be inexpensive to build, remember that economies of scale apply. It can take the same amount of time to produce 10 and 30 gallons of biodiesel. Buying chemicals in bulk and mixing batches in a safe and efficient reactor saves time, money and headaches in the long run.

There are many designs for building a processor and countless turn-key kits available. An in-depth discussion of processor design and construction is beyond the scope of this publication, but more information is available in the Further resources section.

### **Making a table-top batch of biodiesel**

In the past, many biodiesel enthusiasts made demonstration batches using a kitchen blender. We strongly recommend that you DO NOT make biodiesel in a blender. The high speed of operation can cause splashing of caustic chemicals, and the rubber and plastic parts can degrade and leak. The easiest and safest method to try a small batch of biodiesel is the one originated by users at [www.biodieselcommunity.org](http://www.biodieselcommunity.org). Nicknamed the "Dr Pepper Technique," it utilizes a 2-litre plastic soda bottle as a sealed mixing vessel to safely mix a small batch. Below is the author's adaptation of this method.



## Materials

1 litre of new vegetable (cooking) oil

Catalyst, either sodium hydroxide or potassium hydroxide

Methanol, commonly available as HEET fuel line treatment in the yellow bottle. DO NOT use Iso-HEET in the red bottle; this is isopropyl alcohol.

## Equipment

Clean, dry 2-liter soda bottle

Measuring cup or graduated beaker

Scale

Glass jar to mix the methanol and catalyst to produce methoxide

Funnel

Rubber gloves

Safety glasses



Before beginning, make sure that you have all of the equipment and materials you need to complete a batch.

Mixing the methoxide is the most potentially hazardous step in the biodiesel process. Make sure that you mix the methanol and catalyst in a clean glass jar with a tight fitting lid. DO NOT mix in a plastic container because the container may dissolve. Do your mixing in a well-ventilated area, as the methanol fumes are toxic.



Measure 4 grams of sodium hydroxide or 5.6 grams of potassium hydroxide



Measure 250 millilitres of methanol, using a graduated beaker or measuring cup

Measure 4 grams of sodium hydroxide or 5.6 grams of potassium hydroxide using your scale. Add the catalyst to your clean glass mixing jar.

Measure 250 millilitres of methanol, using a graduated beaker or measuring cup to measure. Add the methanol to the glass mixing jar with the catalyst. Stir the methoxide mixture until the catalyst is

completely dissolved. You can also cover the jar with a tight-fitting lid and mix the methoxide by swirling or shaking, but be very careful that your lid is screwed on tightly and completely free of leaks. It will take a few minutes for the catalyst to dissolve completely, so be patient. The mixture creates heat as the chemical reaction takes place and the jar will feel warm. This is normal.



Measure 1 litre of oil into the 2-liter soda bottle.



Add the methoxide solution to your oil.

Measure 1 litre of oil, and use your funnel to pour it into the 2-liter soda bottle. You will get a better reaction if the oil is warm. About 140° Fahrenheit (60°) is ideal. You can heat the oil in a pan on the stove or just leave it in the sun for an hour. If you choose to pre-heat the oil, be very careful not to get the oil hotter than 140°F.

Add the methoxide solution to your oil. Use a funnel and be careful not to spill. If you spill, clean up the material immediately with paper towels and dispose of the contaminated paper towels safely.



Put the cap on the soda bottle and shake vigorously.



A layer of darker liquid will begin to form on the bottom of the bottle.

Put the cap on the soda bottle and shake vigorously for about 30 seconds. Let the mixture settle and then shake again for about 10 seconds every 10 minutes; repeat this three times.

Allow the bottle to stand for an hour. The mixture will begin to clear almost immediately and a layer of

darker liquid will begin to form on the bottom of the bottle.

The darker layer on the bottom of the bottle is glycerol, the by-product of the transesterification process. You can now drain off the glycerol by taking off the bottle cap, covering the open mouth of the bottle with your thumb and inverting the bottle. Wear gloves. Allow the glycerol to collect in the neck of the bottle and then use your thumb as a valve to drain the darker liquid into another container. Discard the glycerol by composting or use it as a degreaser. What remains in the bottle is useable biodiesel.

*Photos by Ericka Dana.*

## The Appleseed processor

For the last several years, many do-it-yourselfers chose to avoid the more-expensive kits on the market and opted to build their own processor using an electric water heater as the reactor. This water heater-based platform was developed by biodiesel home brewer Maria Alover. Alover, or Girl Mark as she is commonly known on Internet biodiesel forums, set out across the country in 2004 to share her open-source design through a series of workshops. Because Alover spread her design like the nurseryman Johnny Appleseed spread apple seeds across Ohio, Indiana and Illinois, her design became known as the Appleseed. Links to complete Appleseed plans are available in the Further resources section.

The Appleseed design uses the water heater's existing tank, plumbing, insulation, thermostat and heating element as the starting point for a remarkably simple, reliable and inexpensive design. Although a used water heater can often be found for free, they can be problematic if they leak or contain large amounts of rust, limescale or other impurities. A new electric water heater can be found on sale at home centres for as little as \$200. The plumbing parts, pumps and electrical supplies necessary for the completion of the unit can be purchased for about \$150.

In this design, the oil is pumped into the water heater tank, brought up to a constant temperature of 130° Fahrenheit (54°C) using the built-in heating element and thermostat. While heating, the methanol and catalyst are premixed in a high-density polyethylene (HDPE) carboy or jug. The oil is circulated from the bottom of the tank to the top, and the methoxide is introduced slowly from the carboy through a permanent hose. This greatly reduces the risk of spilled chemicals and injury. After about an hour of mixing, the circulating pump is turned off and the glycerol settles to the bottom, where it can be drained off. The biodiesel can then be pumped out to another tank for washing and drying.

One of the beauties of this design is that, by using a series of bypass valves, the same one-half horsepower centrifugal pump can be used for filling, mixing and emptying the reactor. This is also a very safe design appropriate for small-scale production.

Many variations on the design are available for free online, as well as designs for countless add-ons like standpipe wash tanks, drying systems and methanol recovery systems. For the serious do-it-yourselfer who wants to produce high-quality biodiesel for the smallest investment, the Appleseed is a good design to explore.

## Washing biodiesel

Unwashed biodiesel will not meet ASTM, formerly known as the American Society of Testing and Materials, standards. For more information about ASTM standards and testing and specifications for biodiesel and other diesel fuels, see the Further resources section. Remember, equipment and engine manufacturers only warranty their equipment and engines for their material and manufacturer defects. Fuel manufacturers assume responsibility for any damage caused by the fuel. Washing biodiesel is easy to do, and requires only water and time.

## Why wash biodiesel?

The biodiesel produced with the process described above will work in some heating and lighting equipment and may be used to fuel diesel engines. Most impurities settle out into the glycerol layer, including unfiltered particulates, methanol and glycerin. Some sources encourage using unwashed biodiesel because washing biodiesel is a time-consuming process. However, some alcohol, catalyst and soap remain suspended throughout the biodiesel after the transesterification is complete. Water in biodiesel can lead to biological growth as the fuel degrades. Unreacted methanol in the biodiesel fuel can result in fire or explosion and can corrode engine components. The catalyst can also attack other engine components. Because the methanol and catalyst are chemical bases, unwashed biodiesel is caustic and may damage diesel engine components. Soap is not a fuel and will reduce fuel lubricity and cause injector coking and other deposits. In the small-batch scale described above, it is not feasible to reclaim the methanol. When making significant quantities of biodiesel, reclaim the unreacted methanol because the reclaimed methanol represents a significant cost savings and methanol is a pollutant in its own right.

## Washing your test batch

You can easily wash your 1-litre test batch by slowly and gently adding water to your bottle until it is full. Allow the water to settle to the bottom and then use the same technique used to remove the glycerol. Covering the mouth of the bottle with your thumb, invert the bottle, allow the water to settle and then drain it off using your thumb as a release valve. Wear gloves. Repeat the process. After washing, the biodiesel will be cloudy with an appearance similar to orange juice. This is because of residual water trapped in the fuel. Do not use the fuel until you have allowed it to sit with the top off until it is clear. Then you know the fuel is dry.

## Washing techniques

There are several common techniques for washing biodiesel, including agitation washing, mist washing and bubble washing. The process of washing biodiesel involves mixing it with water. Water is heavier than biodiesel and absorbs the excess alcohol, catalyst and soap suspended in the fuel. After washing and settling, the water and the impurities in the water can be drained from the bottom of the container. Several wash cycles are generally needed. The first water drained off the bottom of the biodiesel will be milky, and the final wash water drained off will be clear. Excess catalyst in the biodiesel will form soap when mixed with water, and it takes awhile for the soap to settle out. Depending on the method used, it takes roughly 1 gallon of water per 1 gallon of biodiesel for a wash cycle. The mixing should be thorough and the water should be dispersed throughout the biodiesel. Agitation washing means stirring water into the biodiesel, letting it

settle and draining it off. Mist washing is spraying a fine mist of water over the surface of the biodiesel. Tiny droplets of water fall through the biodiesel and pick up impurities on the way down. Bubble washing is done by putting a bubbler in a layer of water beneath the biodiesel. The rising bubbles are coated with water, which picks up impurities as the water travels up and then back down through the biodiesel.

## Washing a larger batch

Building a basic washing system is simple. One option is to use a misting nozzle similar to those used in a grocery store produce department. Using an open-head 55-gallon drum or other container with a drain valve connected at the bottom, suspend the mist head over the barrel and plumb to a water supply with hard pipe or a garden hose. Fill the container about half full of biodiesel, and then turn on the water and allow the mist head to gently spray the surface of the biodiesel. In a short time, the water will fall to the bottom and be removed through the drain valve. For bubble washing, use an aquarium air pump, hose and air stone. For a larger washing tank, a perforated pipe connected to an air compressor can be used. Gently add about one-third as much water as you have biodiesel to wash. Start the air pump or compressor and allow the bubbles to gently wash the biodiesel for several hours. Drain the milky water, and repeat this process, letting the air pump run longer during each washing cycle, until the water remains clear. If the bubbles cause foam to form, use less air.

## Drying washed biodiesel

After the biodiesel is washed, it should be dried until it is crystal clear. This can be done by letting the biodiesel sit uncovered in a sunny location for a few days, or it may be heated to about 120 degrees Fahrenheit for a few hours. Another popular technique is recirculating the biodiesel from the bottom of the drying tank through a shower head or sprayer suspended above the top of the open tank. This increased contact with air will dry biodiesel in about an hour, depending on humidity. Reacted, washed and dried biodiesel may be used in any diesel engine. It should have a pH of close to 7, or chemically neutral, and it should have no methanol left in it. Although professional testing of fuel may be prohibitively expensive, simple home fuel test kits can be purchased for a reasonable price. One such kit, The Biodiesel pHlip Test, can be found at [www.phliptest.com](http://www.phliptest.com).

## Methanol recovery

Because much of the methanol used in transesterification remains in the by-product after reaction, it can be advantageous to recover the unused alcohol for several reasons. First, reusing the recovered methanol can save a considerable amount of money when producing significant volumes of biodiesel. Second, once the alcohol is removed the glycerol by-product becomes glycerin, a much more environmentally friendly product with countless uses.

Methanol recovery can be achieved through the distillation process by heating the glycerol to a temperature above the boiling point of methanol, 148 degrees Fahrenheit at sea level. This temperature is lower if the process is performed at a lower pressure. Attaching a vacuum pump to the distilling tank lowers the danger of explosion. The vaporized methanol must then be passed through a condenser, cooled and recaptured as a liquid. Biodiesel researchers and enthusiasts are currently exploring several systems and links to more information can be found in the Further resources section of this publication. Several methanol recovery systems rely again on a water heater to provide a relatively safe, sealed tank to heat the glycerol and automotive condensers or homemade cooling towers. Because biodiesel made with sodium hydroxide will produce a



glycerol that is more solid when cool, it is best to use potassium hydroxide if recovering the methanol, or pump the sodium hydroxide methanol directly in to the distilling unit while it is still hot.

## Glycerol disposal

One of the major issues to deal with in biodiesel production is the disposal of glycerol, the methanol-laden glycerin by-product of biodiesel production. While the methanol in the glycerol may biodegrade up to 97 percent within 72 hours, methanol-laden glycerol should be handled as a hazardous material. There is debate, though, as to the actual hazard posed by glycerol. Some people use small quantities as a dust suppressant, degreaser or weed killer. Glycerol can be burned in a waste oil burner or added to a biodigester or a proper compost pile, where it can safely be converted to fertilizer. Glycerol has about the same feed value as corn and there are numerous university studies documenting its use as a feed supplement. Check local regulations before disposing of glycerol. NEVER dump glycerol in a ditch or waterway and DO NOT pour into drains or toilets, especially if you have a septic system.

## Conclusion

This publication is meant as a starting point for making biodiesel. It is not a complete reference guide and we encourage you to explore all of the additional information supplied in the Further resources section. One of the best ways to learn about making biodiesel is by joining a local biodiesel club or group. Classes are offered in many areas through local clubs, community colleges and farm groups. Make sure that you have as much information as possible before mixing your first batch, and always remember – SAFETY FIRST.

## Further resources

Unless noted, none of the biodiesel resources cited below are affiliated with NCAT.

### Books

Biodiesel Homebrew Guide: Everything you need to know to make quality alternative diesel fuel out of waste restaurant fryer oil. Maria "Mark" Alovert.

Biodiesel Power: The Passion, the people, and the politics of the Next Renewable Fuel. Lyle Estill.

### Internet discussion groups

Joining these groups can be a great way to learn from those who are producing biodiesel. This is only a sampling of forums on topics like homebrew biodiesel, straight vegetable oil and home heating.

Biodiesel & SVO Discussion Forums

Yahoo Biodiesel Group

Yahoo Biodiesel Basics Group

Frybrid Diesel/Vegetable Oil

### Biodiesel cooperatives

Piedmont Biofuels Coop

Yoderville Biodiesel Collective

### Web resources

Journey to Forever

*Journey to Forever is a small, non-government organization based in Japan and involved in Third World rural development work. The Web site also offers a lot of information about other appropriate technologies.*

Biodieselcommunity.org

*A collaborative, web-based tutorial run by and for people who make their own biodiesel.*

National Biodiesel Board

## **Government agencies with biofuels information**

Oak Ridge National Laboratories

Biodiesel publications from the National Renewable Energy Laboratory

*This site offers PDF and HTML files about biodiesel production, handling and use; biodiesel quality, stability and compatibility; biodiesel emissions; and biodiesel fleet evaluations.*

## **Standards and testing, chemical composition of biodiesel**

National standards for biodiesel, from Journey to Forever

ASTM Standards

Cetane Number Testing of Biodiesel [PDF/257KB]

Titration scale

## **Glycerin uses**

Glycerin, from Journey to Forever

Straight vegetable oil as diesel fuel, from Journey to Forever

## **Biodiesel& SVO Discussion Forums**

Frybrid Diesel/Straight Vegetable Oil

## **Reclaiming methanol**

BioLyle's Biodiesel Workshop

## **Safety**

Biodiesel Safety and Best Management Practices for Small-Scale Noncommercial Use and Production, from Penn State College of Agricultural Sciences [PDF/957KB]

Collaborative Biodiesel Tutorial: Biodiesel Safety

Occupational Safety and Health Administration

## **Respirator selection**

National Institute for Occupational Safety and Health Pocket Guide to Chemical Hazards

## **Making soap using biodiesel waste**

Soap, from Journey to Forever

## **Biodiesel as a home heating fuel**

Bio Heat

Heaters, burners and stoves, from Journey to Forever

---

MOREE WATER & BIODIESEL Commercialization Demonstration – YEAR 1

Process Route:

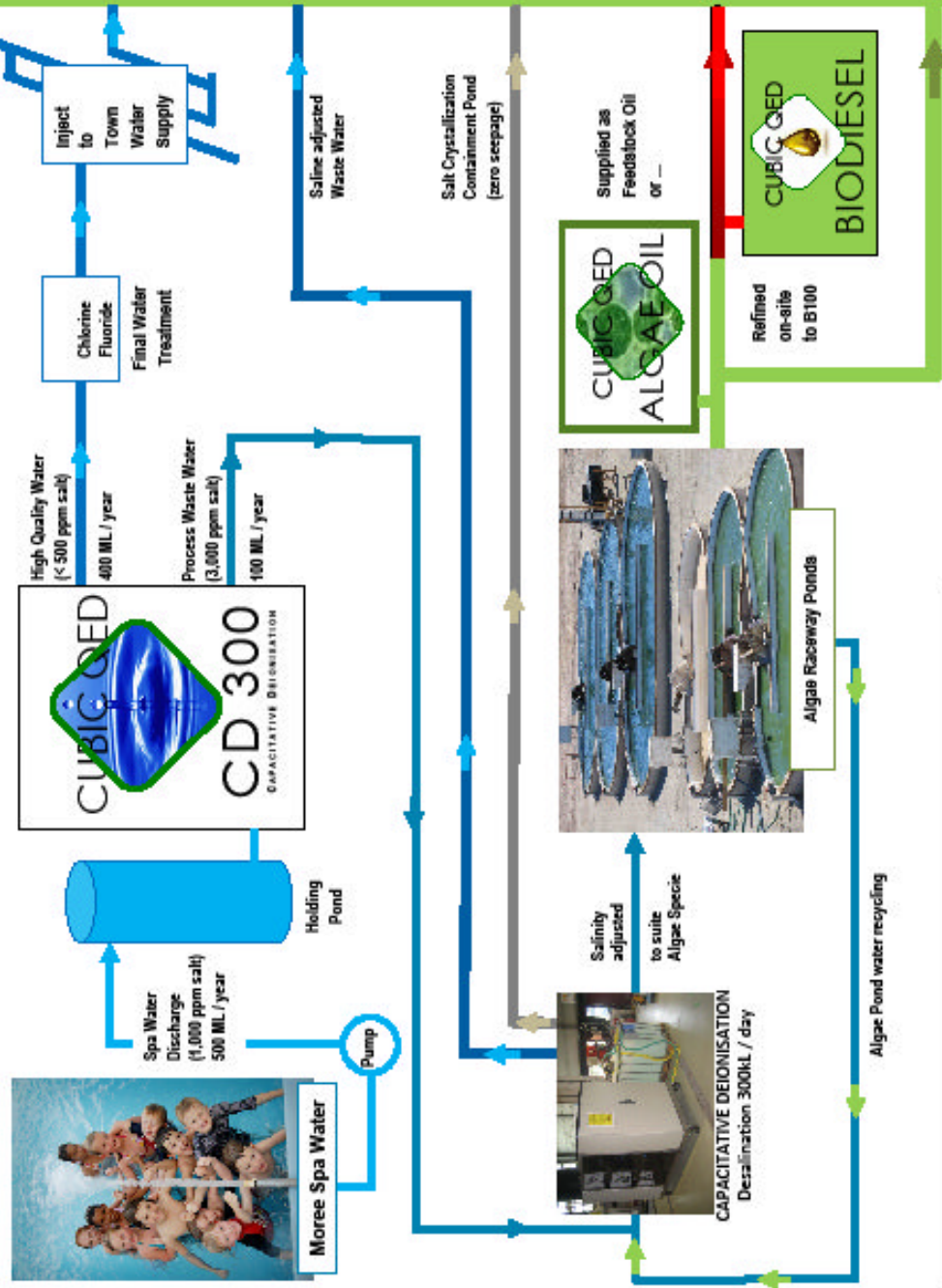

Community Benefits:



CO<sub>2</sub> absorbing Salt Tolerant Poplars

Est. 30 tonnes / Yr 1  
Crystallized salt to Salt Producers



330,000 Litres / Yr 1 Biodiesel  
900 tonnes / Yr 1 Dried Algae Cake for stock feed processing

Copyright © 2009 Cubic QED Ltd. All Rights Reserved







NIES-629 *Chlorella protothecoides*

10  $\mu$ m



South Australian R&D Institute – *Photo Bioreactor*



## HYDROGEN HYBRID MOTORS:

<http://www.hhmotoring.com/>



Welcome to Hydrogen Hybrid Motoring, the website that will **save you money.**

This is Australia's first company that is solely dedicated to Hydrogen technology for the internal combustion engine, technology which is revolutionising the motoring world. Already in use in Europe, Canada, America, and now Australia.

*The technology that we are promoting is aimed at supplementing whatever fuel you use (petrol / diesel / LPG), to assist the burn of the fuel more efficiently therefore releasing more energy. Normally this would have otherwise ended up coming out of your exhaust pipe as unburnt fuel (wasted money). Hydrogen increases your economy, power and substantially reduces the emissions generated by the engine.*

This is similar in concept to LPG injection used in diesel engines as a modification to increase their performance by enabling more of the fuel to be burnt more completely, by enhancing the combustion process with LPG. However the Hydrogen system it is cheaper to and run as you are using distilled water to generate Hydrogen.



There are no pressurised storage tanks required taking up valuable space, you don't have to continue to pay for the purchase of LPG, which is getting more expensive, just some distilled water once a month. The system takes up minimal space and is easy to install and run.

*The hydrogen is generated and is introduced into the engine via the air inlet, downstream of the air filter where it mixes with the incoming air before entering the cylinder and being ignited, and burning the introduced fuel more efficiently. No internal engine modifications are required, and you will definitely notice a smoother running motor as well.*

**Sound too good to be true? Well this technology has been validated by the University of South Australia, that's right, an Australian University, and the link for this research paper is included on our website. We also offer a money back guarantee, that's how confident we are that you will embrace this technology and also make significant fuel savings.**

**Diesel trucks are showing upwards of 30% increase in economy (1996 Mack, 300hp) using this concept. These units are made in the USA (NOT CHINA), and are the way of the future.**



HHO Dry Cells



Complete Systems



Premiere Systems



Speciality Systems



Components

## Hydrogen Hybrid Motoring

The one constant when it comes to motoring is that we are always chasing better fuel economy and more power.

To burn fuel more efficiently and to unlock more of the stored energy within the fuel we use instead of expelling it as un-burnt fuel in the exhaust gases is one of the keys in achieving these goals.

This has been achieved in the past by using higher octane fuels, hotter spark plugs, enhanced ignition systems and better airflow to name just a few. All of these, enhancements are ways to burn the fuel more efficiently, so that more energy will be released and therefore requiring less fuel due to achieving a more complete combustion with the added benefit of subsequently reduced carbon emissions.

Another way this also being achieved successfully with diesel engines is the injection of LPG into the inlet manifold to increase the flame speed and burn temperature thereby unlocking more of the energy stored in the diesel fuel itself. There are however some drawbacks with the LPG system, for example it takes up a significant amount of room with the tank etc, and you still have to purchase LPG.

There is however an alternative gas that can be used to increase the flame speed and efficiency of burn within the cylinder and that is HYDROGEN and where Hydrogen Hybrid Motoring steps in.

## Basic Principles of Hydrogen Production

The water molecule is made up of atoms, 2 atoms of Hydrogen (H<sub>2</sub>) and 1 atom of Oxygen (O) which is why the chemical symbol for water is H<sub>2</sub>O.



The Hydrogen atoms have a positive charge and the Oxygen a negative charge, so if a positive and negative electrode is placed in water and an electrical current (energy) is passed through it, the atoms 'split' back to their elemental forms, with hydrogen moving to the negative electrode and oxygen to the positive electrode. Having been supplied the energy to free themselves of each other, these two elements return to their former gaseous states. This process of using electricity to split water molecules into its separate parts is called electrolysis. This is also known as Brown's Gas or HHO and it is only mentioned for those who would like to research it further. Although it is interesting to note that the first Hydrogen / Oxygen generator was invented and patented in 1918, by Charles Frazer.

## What Happens to the Hydrogen and Oxygen?

The gaseous mixture is then introduced, under its own low pressure, into the air inlet of the engine downstream of the air filter where it mixes with the incoming air to be utilized in combustion.

This mixture burns hotter and faster and this helps complete the combustion process of the fuel. It burns MORE of the carbon chains present in the fuel to create lower emissions (fewer hydrocarbon and carbon monoxide particles). The product of burning hydrogen is water vapour, which excess heat (a cooler running engine) and offers more power to the driver as a result.

Put simply, because it releases more energy from the fuel, with no requirement to change internals as you would have to with LPG systems.

## Emission Reduction

As the fuel is burnt more efficiently and therefore more cleanly, it reduces the carbon emissions substantially, four fold in some cases.

In the era of looming carbon taxes, these systems will have a significant impact on company expenditure.

## FAQ & Support Articles

### ***How much economy will I gain?***

It depends on the amount of HHO and the type of engine, age of engine, age of oxygen sensors, driving style etc. Each application will have varying results, but all will have one thing in common, when installed correctly, you will increase the economy of your vehicle / boat.

### ***What powers the Dry cell?***

The Dry cell Generator is powered by electricity (12v) from your vehicle's electrical system. The draw is about 2-10 amps per cell so the additional load on your alternator is small. Even are largest cell only requires 30-40 amps.

***What if I have a Hybrid car?***

A Hybrid still has a petrol / diesel engine in it so yes, although the increases may not be as great as with a normal car.

***Can the engine run on HYDROGEN only?***

No, your engine will always run on its original fuel either in combination with HYDROGEN or without.

***What types of engines will it work with?***

This system will work with almost any internal combustion engine, whether it be for a car, truck, boat, generator, etc.

***After installation, is there any special servicing required?***

No, there isn't any special servicing required apart from the addition of distilled water. The frequency of this depends on the unit installed, current operated at, etc. However, as some preventative maintenance, it is a good idea to flush the system perhaps once a year, although this is not really necessary if clean distilled water is utilised.

***Will the addition of Hydrogen affect engine life?***

The use of hydrogen to enhance fuel combustion can improve engine life by reducing engine oil contaminants and reducing carbon build up on combustion chambers, valves and exhaust systems and by making the engine more efficient. The H<sub>2</sub> System also reduces "diesel knock" and this is often discernable by a smoother, quieter running engine. Both of these effects are achieved because of the cleaner and more efficient combustion process of the diesel and hydrogen mix.

***Can the H<sub>2</sub> System be moved to my next truck?***

Yes, the System is transferable from vehicle to vehicle.

***Will my converted engine suffer a loss of performance?***

No, the engine may be more responsive at lower revs resulting in less gear changes and improved ability to pull loads up hills.

***What are the best electrolytes?***

The best electrolytes are potassium hydroxide (KOH) and sodium hydroxide (NaOH) they are not consumed during electrolysis.



The use of baking soda, salt or battery acid will damage your electrolyzer, and, may produce harmful gas outputs.

***What is an electrode?***

An electrode is a metal conductor which when placed in the electrolyte and has an electrical current applied to it will pass that current through the electrolyte to the oppositely charged electrode. Two electrodes are needed, one positive, the other negative.

***What materials make the best electrodes?***

NSS 445M2 Stainless Steel is the best metal to use followed by 316L-grade stainless steel as second best. Other cheaper grades of Stainless steel i.e. 302 or 304 release ferrous deposits causing the electrode to wear away and also stain the electrolyte a muddy colour.

***How thick should electrodes be?***

The surface area of an electrode is the important thing, thickness only adds to the cost and weight. If the material is too thin, the chance of distortion can cause problems due to flexing, keeping in mind that electrodes are very close together in a cell.

***Do the electrodes wear out?***

In a properly designed cell, with the use of the correct electrolyte and water, the unit will last many years.

***What current is needed?***

Electrical current is usually in the 5 amps to 20 amps range, larger cells used for big vehicles i.e. semi trailers, bulldozers, etc may use as high as 70 Amperes. These vehicles usually have much higher rated alternators that can produce the needed current.

***Can I use any kind of water?***

As tap water, and even rainwater and especially saltwater have mineral deposits, residues are left behind in your cell and will build up and damage the cell, reducing its life span. It is highly recommended that distilled or de-ionized water is used. Remember that you only add distilled water to the electrolyte as only water is consumed during the electrolysis.

***What happens if I forget to top the system up with water?***

As the water is consumed, the electrolyte becomes more concentrated. As the concentration rises, more current is passed and also a rise in temperature will occur. The rise in current flow if left to continue will cause the fuse to blow. It is recommended that instead of a fuse to use a circuit breaker instead, and



keep an eye on your electrolyte levels. The best idea is to use a Pulse Width Modulator, which will control the current to the cell.

***Can I use Hydrogen with a turbocharger?***

No problem, just connect the outlet of the generator air intake side of the turbocharger.

***Why haven't the major car manufacturers aren't using this technology?***

A very good question, and I have no answer, conspiracy? who knows, all I know is the system works and more and more people are beginning to use it.

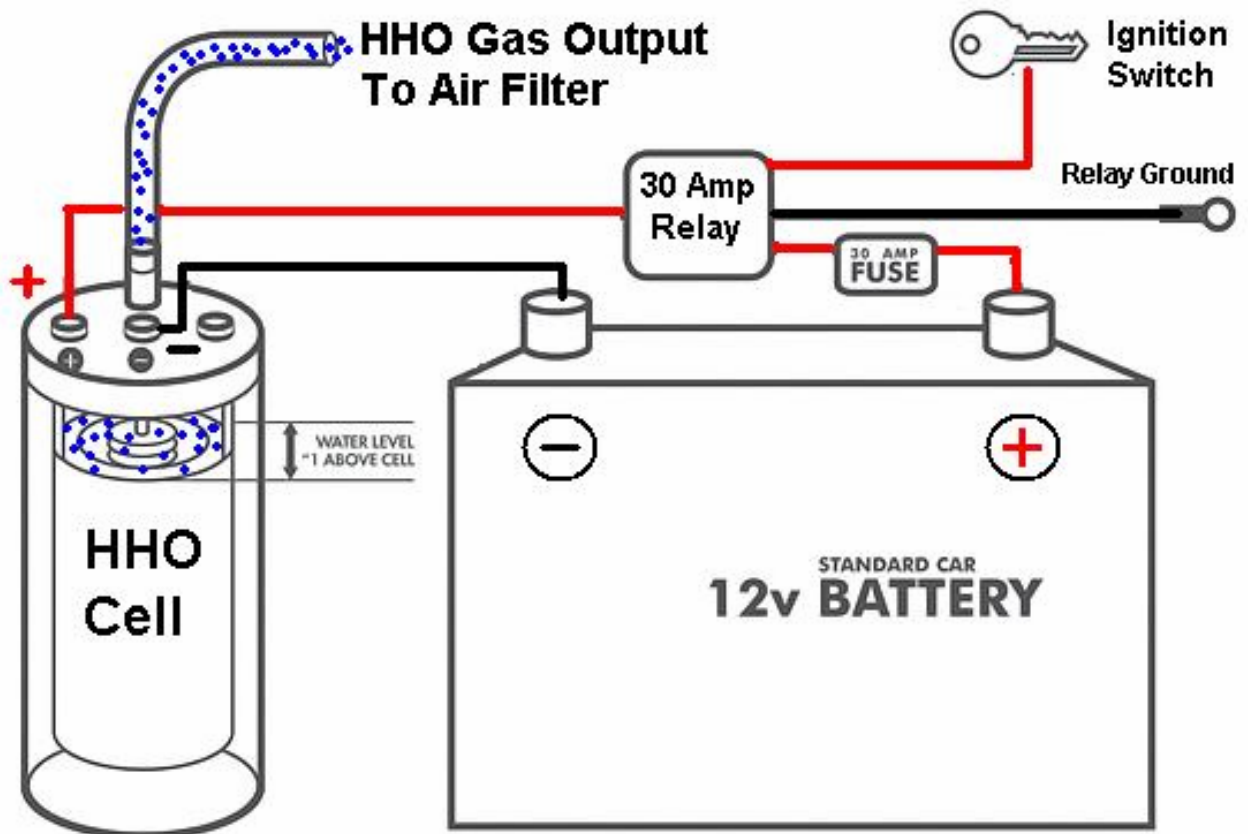

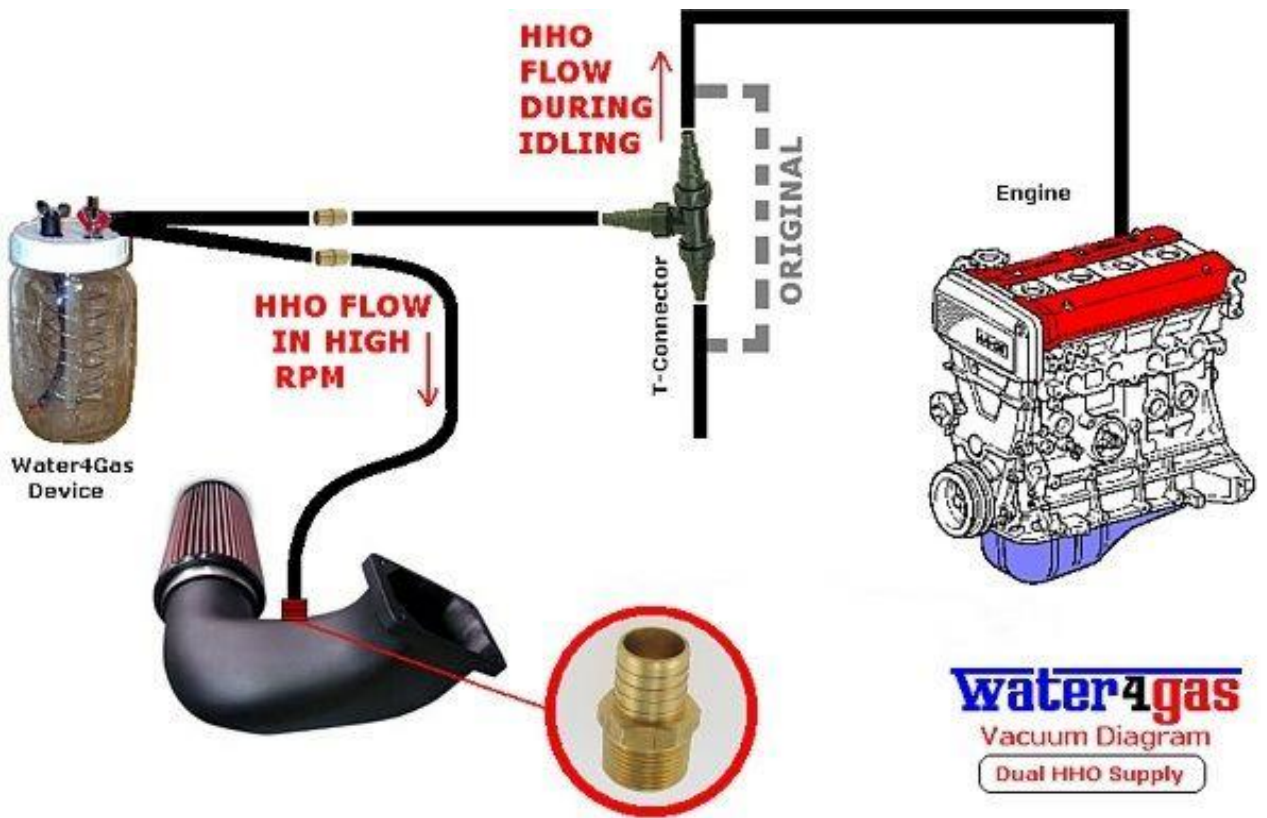

# Ten Super Plants Fighting the Environmental Injustice League

<http://www.miller-mccune.com/science-environment/ten-super-plants-fighting-the-environmental-injustice-league-3742/>

Here at Miller-McCune, we've scanned the literature for the top 10 most promising trees, shrubs and other flora that are making our lives more sustainable. From the depths of the Patagonian rainforest to the drylands of South Africa, promising natural sources of biofuels abound, but so do new options for carbon storage and water purification. And now, with the help of biological engineering, scientists are creating new ways for plants to clean up our messes and literally grow pharmaceutical or formerly petroleum-based products.

"Captain Biodiesel" alter ego: *Jatropha Curcus*

Hydro alter ego: Duckweed

"Commander Carbon" alter ego: Spekboom

"The Spore" alter ego: *Gliocladium roseum*

"Madame Salt" alter ego: Dwarf Glasswort

"Rubber Root" alter ego: Guayule

"The Tidy Team" alter ego: Tobacco, Edenfern, Thale Cress

"Dr. Pharm" alter ego: Safflower

"The Grass Giant" alter ego: *Miscanthus*

"Prof. Plastic" alter ego: *Arabidopsis thaliana*





## BioDiesel Technologies & Jatropha in Brazil

[http://www.treehugger.com/files/2007/08/jatropha\\_biodiesel.php](http://www.treehugger.com/files/2007/08/jatropha_biodiesel.php)

Jatropha has been hailed as one of the best biodiesel crops in existence. Some of the more impressive features are the large yields of quality oil, and the ability to grow the plant with minimal water or fertilizer.

"Brazil's first commercial jatropha biodiesel project goes into operation this month following the delivery of BioDiesel Technologies' (BDT) processing unit. BDT will deliver an additional four processing units to increase the plant's annual capacity to 40,000 tonnes (about 10 million gallons US) by the end of 2007."



Jatropha is known to be toxic to animals and humans, which has raised some questions about the safety of Jatropha oil and handling conditions for farmers. In the rush to biofuels are we missing some unintended consequences? While there is no single solution to biofuel production, public safety measures should be considered, especially in light of research showing that there may exist non-toxic Jatropha varieties. It would be a shame to plant all those acres to realize you could have not only made a safer oil, but fed your cow, and possibly your family as well.

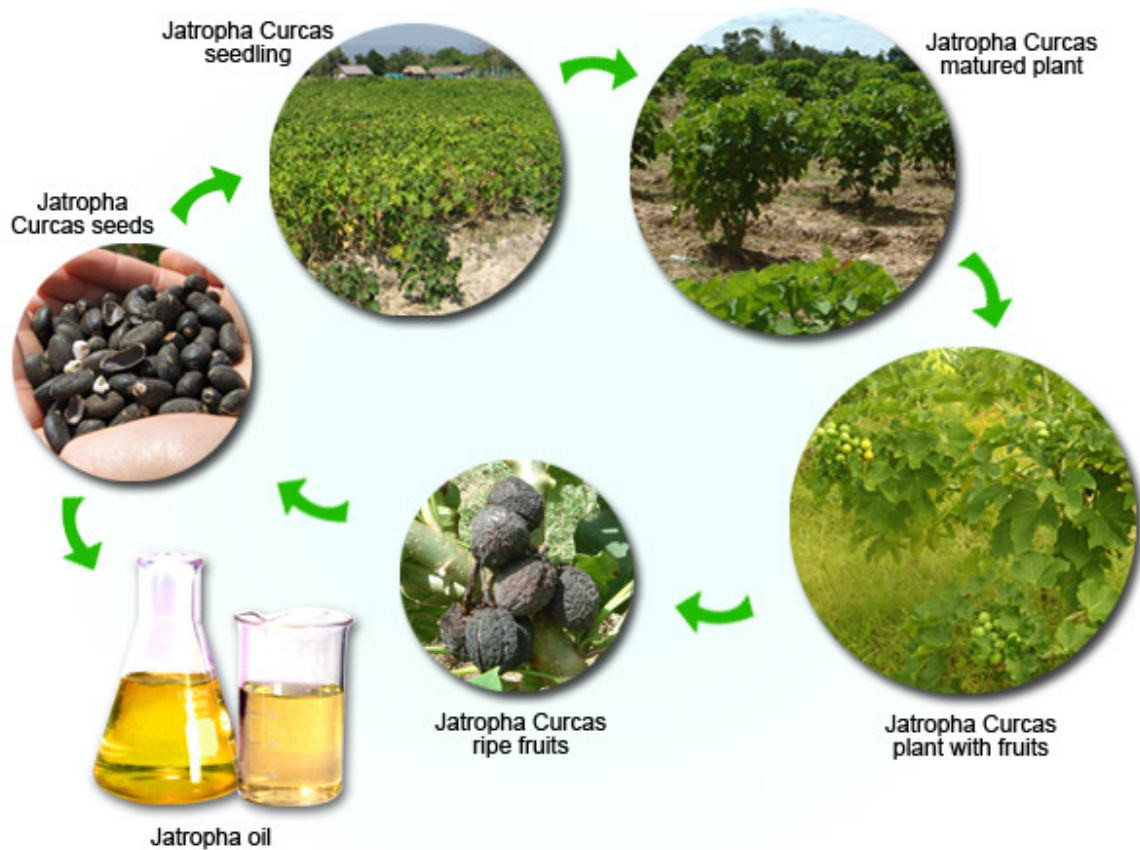

### Utilization of Jatropha Curcas Seeds & Sustainable Cycle

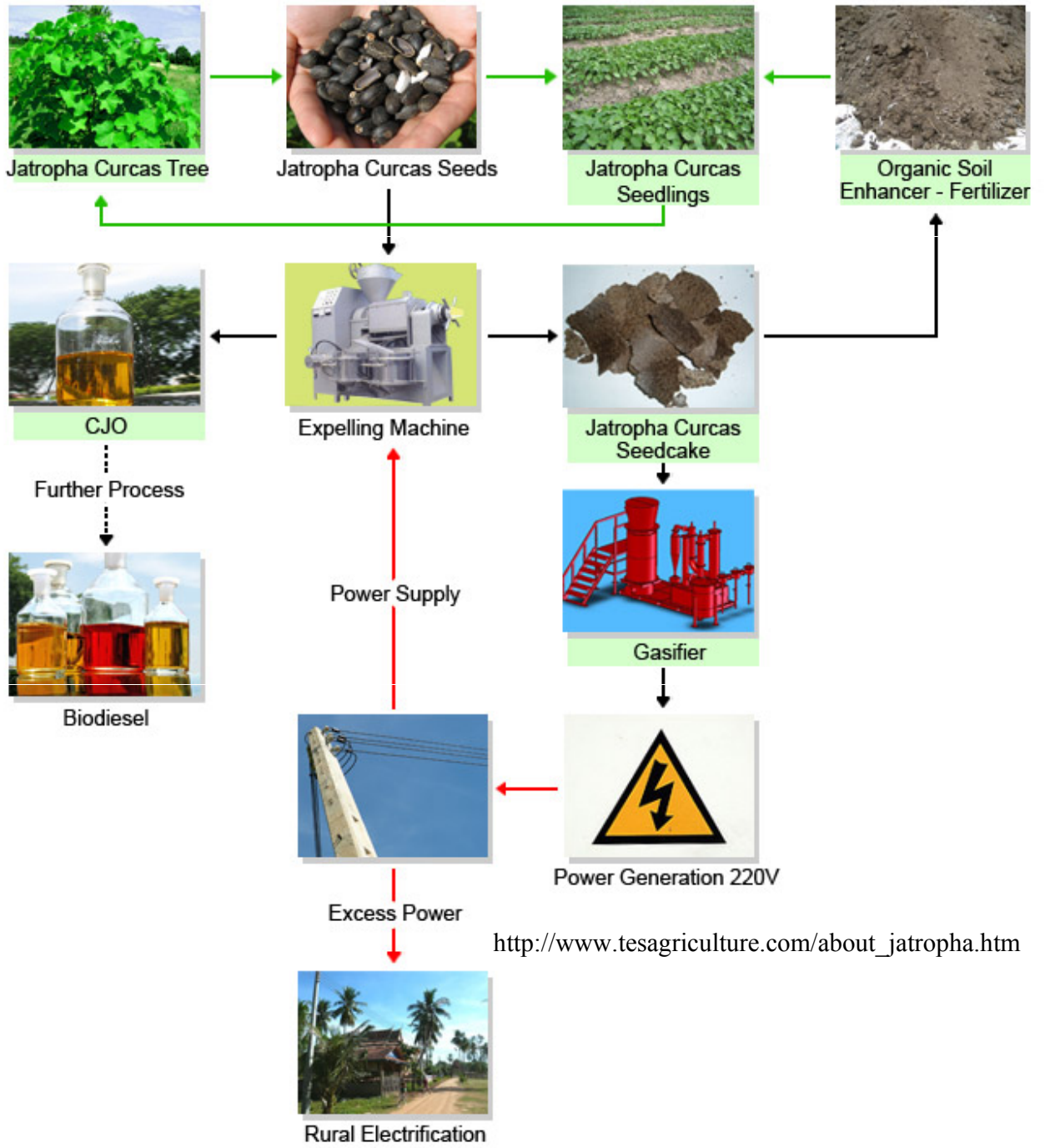

[http://www.tesagriculture.com/about\\_jatropha.htm](http://www.tesagriculture.com/about_jatropha.htm)